

# PRECISE DEAD-RECKONING FOR MOBILE ROBOTS USING MULTIPLE OPTICAL MOUSE SENSORS

Daisuke SEKIMORI

*Akashi National College of Technology  
Akashi, Hyogo 674-8501, Japan*

Fumio MIYAZAKI

*Graduate School of Engineering Science, Osaka University  
Toyonaka, Osaka 560-8531, Japan*

Keywords: dead-reckoning, mobile robot, optical mouse sensor.

Abstract: In this paper, in order to develop an accurate localization for mobile robots, we propose a dead-reckoning system based on increments of the robot movements read directly from the floor using optical mouse sensors. The movements of two axes are measurable with an optical mouse sensor. Therefore, in order to calculate a robot's deviation of position and orientation, it is necessary to attach two optical mouse sensors in the robot. However, it is also assumed that a sensor cannot read the movements correctly due to the condition of the floor, the shaking of the robot, etc. To solve this problem, we arrange multiple optical mouse sensors around the robot and compare sensor values. By selecting reliable sensor values, accurate dead-reckoning is realized. Finally, we verify the effectiveness of this algorithm through several experiments with an actual robot.

## 1 INTRODUCTION

For a mobile robot to move around autonomously, it is necessary for it to possess the ability to estimate its position and orientation. The localization of mobile robots is roughly divided into those using internal sensors and those using external sensors. The method using internal sensors is known as dead-reckoning, mainly, and estimates position by measuring and accumulating the rotation of the wheel with the rotary encoder, etc. Dead-reckoning is a convenient estimating method using only internal sensors. However, the accuracy of estimation decreases as the movement becomes longer since the errors of the transformations and wheel slippage accumulate. On the other hand, the method using external sensors estimates the position by measuring positions of a landmark in the environment with a vision sensor or a range sensor. Some error is always caused by resolution or the noise of the sensor; accumulated errors are not caused as such by dead-reckoning. Therefore, because both methods have their respective merits and demerits, the two methods are often used together (Cox, 1989) (Watanabe and Yuta, 1990) (Chenavier and Crowley, 1992).

In the case of the estimation method using both dead-reckoning and an external sensor, it is advantageous to improve the accuracy of dead-reckoning. As for the reason, in general, many of the external sen-

sors are expensive, and processing is very complex. Moreover, estimation methods using external sensors need to have a previously installed landmark in the environment. By improving the accuracy of dead-reckoning and reducing the part that depends on the method using the external sensor, the hardware and software costs of the robot can be decreased, and the time needed to install a landmark can be omitted.

In this paper, in order to develop an accurate localization for mobile robots, we propose a dead-reckoning system based on increments of the robot movements read directly from the floor using optical mouse sensors (Fujimoto et al., 2002). The movements of two axes are measurable with an optical mouse sensor. Therefore, in order to calculate a robot's deviation of position and orientation, it is necessary to attach two optical mouse sensors in the robot (Tobe et al., 2004) (Singh and Waldron, 2004) (Cooney et al., 2004). However, it is also expected that a sensor cannot read the movements correctly due to the condition of the floor, the shaking of the robot, etc. To solve this problem, we arrange multiple optical mouse sensors around the robot and compare sensor values. By selecting reliable sensor values, accurate dead-reckoning is achieved.

In section 2, we explain the optical mouse sensor. In section 3, we describe the algorithm of dead-reckoning based on optical mouse sensors. Finally, in

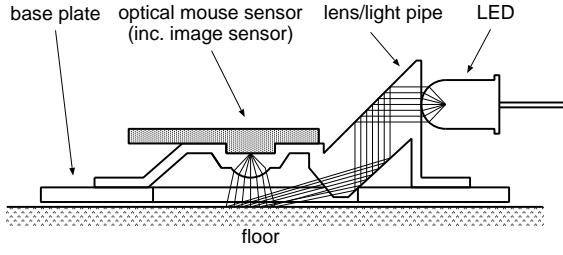

Figure 1: Structure of optical mouse sensor

Table 1: Specifications of the optical mouse sensor (Agilent Technologies, HDNS-2051)

resolution	800 counts/inch
max speed	14 inch/sec
scanning frequency	2300 Hz
power supply	5 volts

section 4, we verify the effectiveness of this algorithm through several experiments with an actual robot.

## 2 OPTICAL MOUSE SENSOR

An optical mouse sensor is built into an optical mouse for personal computers, and measures non-contact movements. It is maintenance free and not influenced by floor friction.

The principle of the optical mouse sensor is that the installed small image sensor reads the change in the image information on the floor and the optical mouse sensor measures movement. The structure of the optical mouse sensor is shown in Fig. 1. An optical mouse sensor takes a floor picture irradiated by a LED through a lens, with the image sensor located on the sensor undersurface. Changes in the pictures taken are processed within the sensor and transformed into distance information. Finally the sensor outputs a two phase pulse from the ports. The main specifications of the optical mouse sensor (Agilent Technologies, HDNS-2051) used in our research are shown in Table 1.

## 3 DEAD-RECKONING BASED ON OPTICAL MOUSE SENSORS

This section describes the basic equation for dead-reckoning based on optical mouse sensors and the comparison method for increasing the reliability of mouse sensor values. In this method, the mobility range of the robot is limited to the floor whereby the optical mouse sensor can initially measure the movement.

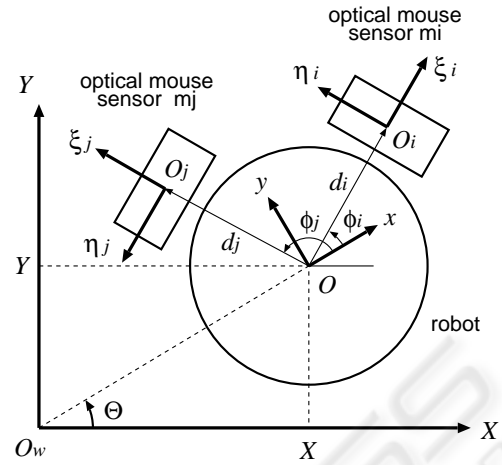

Figure 2: Configuration of robot and optical mouse sensors

### 3.1 Basic Equation

Movement of the direction of two axes is measurable by one optical mouse sensor. Therefore, movement (translation and rotation) of the robot which moves through a plane is calculable by using two optical mouse sensors.

Firstly, a robot and two optical mouse sensors  $m_i, m_j$  are arranged as shown in Fig. 2. The world coordinate system  $(O_w - XY)$  is placed on the floor, the robot coordinate system  $(O - xy)$  is placed on the robot center, and coordinate systems  $(O_i - \xi_i \eta_i)$ ,  $(O_j - \xi_j \eta_j)$  are put on the center of two optical mouse sensors  $m_i, m_j$  attached to the robot. However, axes  $x_{m_i}, x_{m_j}$  of each sensor are located in a radial direction from the robot center<sup>1</sup>. The positions of each sensor in terms of the robot coordinate system are expressed by  $[d_i \cos \phi_i, d_i \sin \phi_i]^T$ ,  $[d_j \cos \phi_j, d_j \sin \phi_j]^T$ . The relation movement  $[\Delta \xi_i, \Delta \eta_i]^T$ ,  $[\Delta \xi_j, \Delta \eta_j]^T$  measured by each sensor and movement  $[\Delta x, \Delta y, \Delta \theta]^T$  of the robot center is expressed as follows:

$$\begin{bmatrix} C\phi_i & -S\phi_i \\ S\phi_i & C\phi_i \end{bmatrix} \begin{bmatrix} \Delta \xi_i \\ \Delta \eta_i \end{bmatrix} = \begin{bmatrix} \Delta x \\ \Delta y \end{bmatrix} + \Delta \theta \begin{bmatrix} -d_i S\phi_i \\ d_i C\phi_i \end{bmatrix} \quad (1)$$

$$\begin{bmatrix} C\phi_j & -S\phi_j \\ S\phi_j & C\phi_j \end{bmatrix} \begin{bmatrix} \Delta \xi_j \\ \Delta \eta_j \end{bmatrix} = \begin{bmatrix} \Delta x \\ \Delta y \end{bmatrix} + \Delta \theta \begin{bmatrix} -d_j S\phi_j \\ d_j C\phi_j \end{bmatrix} \quad (2)$$

<sup>1</sup>It is our goal to decrease the number of parameters used for this method, and the basic equation can be derived regardless of  $\xi_i, \xi_j$  axial direction of each sensor.

Here,  $S\phi_*$  and  $C\phi_*$  mean  $\sin \phi_*$  and  $\cos \phi_*$  respectively, and use this notation as follows. Moreover, upper formulas are arranged as follows:

$$\begin{aligned} \mathbf{A}\mathbf{u} &= \mathbf{a} \\ \mathbf{u} &= [\Delta x, \Delta y, \Delta\theta]^T, \\ \mathbf{A} &= \begin{bmatrix} 1 & 0 & -d_i S\phi_i \\ 0 & 1 & d_i C\phi_i \\ 1 & 0 & -d_j S\phi_j \\ 0 & 1 & d_j C\phi_j \end{bmatrix}, \\ \mathbf{a} &= \begin{bmatrix} \Delta\xi_i C\phi_i - \Delta\eta_i S\phi_i \\ \Delta\xi_i S\phi_i + \Delta\eta_i C\phi_i \\ \Delta\xi_j C\phi_j - \Delta\eta_j S\phi_j \\ \Delta\xi_j S\phi_j + \Delta\eta_j C\phi_j \end{bmatrix} \end{aligned} \quad (3)$$

Here, elements of matrix  $\mathbf{A}$  and vector  $\mathbf{a}$  are replaced with  $A_{pq}$  and  $a_p$  ( $p = 1, 2, 3, 4; q = 1, 2, 3$ ) respectively. Furthermore, the squared error  $E_{ij}$  of movements is defined as follows:

$$E_{ij} = \sum_{p=1}^4 (A_{p1}\Delta x + A_{p2}\Delta y + A_{p3}\Delta\theta - a_p)^2 \quad (4)$$

The movement  $\mathbf{u} = [\Delta x, \Delta y, \Delta\theta]^T$  that has the minimum square error  $E_{ij}$  is determined by using the following equation.

$$\mathbf{u} = \mathbf{A}^- \mathbf{a} \quad (5)$$

Here, matrix  $\mathbf{A}^-$  means a pseudo-inverse matrix of  $\mathbf{A}$ .

After movement  $\mathbf{u}$  of the robot can be determined, dead-reckoning is computed using the following equation and robot position  $[X_t, Y_t, \Theta_t]^T$  in terms of the world coordinate system is determined. In addition,  $[X_{t-1}, Y_{t-1}, \Theta_{t-1}]^T$  expresses the position at a pre-measurement point.

$$\begin{bmatrix} X_t \\ Y_t \\ \Theta_t \end{bmatrix} = \begin{bmatrix} X_{t-1} + \Delta x C\Theta_{t-1} - \Delta y S\Theta_{t-1} \\ Y_{t-1} + \Delta x S\Theta_{t-1} + \Delta y C\Theta_{t-1} \\ \Theta_{t-1} + \Delta\theta \end{bmatrix} \quad (6)$$

### 3.2 Comparison of Values of Optical Mouse Sensors

Robot movements may be incorrectly measured by the optical mouse sensor due to robot speed, robot shaking, the condition of the floor, etc. When errors arise in only one optical mouse sensor between two optical mouse sensors (since the squared error  $E_{ij}$  in (4) will be large), error is detectable by supervising the value of  $E_{ij}$ . However, when an error arises in both of two mouse sensors, there is no corroboration to which the value of  $E_{ij}$  becomes large. That is, error is undetectable when only supervising the value of  $E_{ij}$ . Thus, we proposed a method of computing

robot movements by comparison of the optical mouse sensor values and by selecting reliable sensor values.

The number of optical mouse sensors is  $N$ , the squared errors  $E_{ij}$  ( $i = 1 \cdots N, j = 1 \cdots N (i \neq j)$ ) of all optical mouse sensor values are calculated. Then, threshold  $E_{th}$  of  $E_{ij}$  is decided, and accuracy of a measurement value is evaluated by the following equation.

$$r_i = \sum_{\substack{j=1 \\ j \neq i}}^N \delta_{ij}, \quad \delta_{ij} = \begin{cases} 1 & (E_{ij} \leq E_{th}) \\ 0 & (E_{ij} > E_{th}) \end{cases} \quad (7)$$

Here,  $r_i$  expresses the reliability of optical mouse sensor  $m_i$ . This reliability is computed to each optical mouse sensor, and optical mouse sensors  $m_\alpha, m_\beta, \dots$  with high reliability are elected using threshold  $r_{th}$ . And the following equation is derived using those values.

$$\begin{aligned} \mathbf{B}\mathbf{u} &= \mathbf{b} \\ \mathbf{B} &= \begin{bmatrix} 1 & 0 & -d_\alpha S\phi_\alpha \\ 0 & 1 & d_\alpha C\phi_\alpha \\ 1 & 0 & -d_\beta S\phi_\beta \\ 0 & 1 & d_\beta C\phi_\beta \\ \vdots & \vdots & \vdots \\ \vdots & \vdots & \vdots \end{bmatrix}, \\ \mathbf{b} &= \begin{bmatrix} \Delta\xi_\alpha C\phi_\alpha - \Delta\eta_\alpha S\phi_\alpha \\ \Delta\xi_\alpha S\phi_\alpha + \Delta\eta_\alpha C\phi_\alpha \\ \Delta\xi_\beta C\phi_\beta - \Delta\eta_\beta S\phi_\beta \\ \Delta\xi_\beta S\phi_\beta + \Delta\eta_\beta C\phi_\beta \\ \vdots \\ \vdots \end{bmatrix} \end{aligned} \quad (8)$$

A movement  $\mathbf{u}$  of the robot is calculated by using the following equation.

$$\mathbf{u} = \mathbf{B}^- \mathbf{b} \quad (9)$$

In addition, when two or more sets of optical mouse sensor values with high reliability do not exist, movement of the robot is computed based on wheel rotation.

## 4 EXPERIMENTS

In order to evaluate our methods, experiments were executed using our robot. Firstly, we explain the system configuration of the robot. After that, we show the results of self-localization using dead-reckoning based on optical mouse sensors. Finally, we make one evaluation of our method by reporting on the results of the integration of the global camera information and the dead-reckoning value using the Kalman Filter.

Table 2: Specifications of the mobile robot

height	120 [mm]
width	262 [mm]
weight	2 [kg]
max speed	1000 [mm/s]

Table 3: Planned path cartesian coordinates

	1	2	3	4	5
X [mm]	0	500	500	500	500
Y [mm]	0	0	0	500	500
$\Theta$ [rad]	0	0	$\pi/2$	$\pi/2$	0
	6	7	8	9	10
X [mm]	1000	1000	1000	1000	1500
Y [mm]	500	500	1000	1000	1000
$\Theta$ [rad]	0	$\pi/2$	$\pi/2$	0	0

### 4.1 System Configuration

The robot we have been developing is shown in Fig. 3, and its control flow is shown in Fig. 4. The robot has an omni-directional mobile mechanism driven by three omni-directional wheels. Four optical mouse sensors are attached around the robot. And in order that an optical mouse sensor may stably scan a floor, the sensor unit is forced onto the floor by springs. Moreover, the CPU board and control board are mounted onto the robot. And they control driving motors and count the pulse from optical mouse sensors. The main specifications of the robot are shown in Table 2.

### 4.2 Dead-Reckoning Based on Optical Mouse Sensors

We used two robot speeds: (a)  $v=300$ [mm/s],  $\omega=1.82$ [rad/s] and (b)  $v=500$ [mm/s],  $\omega=3.03$ [rad/s] in the experiments. Speed (a) is slower than the maximum measurement speed of the optical mouse sensor(see Table 1), and speed (b) is faster. We determined speed (b) to be the general maximum speed of an indoor mobile robot. The motion path of the robot is shown in Table 3. The floor is covered with the felt mat used in the RoboCup small size league competitions. Moreover, in order to measure a robot's real trajectory, a camera is installed on the ceiling.

The comparison result of the real trajectory and dead-reckoning values based on wheels, two optical mouse sensors, and four optical mouse sensors are shown in Fig. 5. As a result, when a robot speed is (a), even if the dead-reckoning value based on the wheels greatly differs from the real trajectory, two dead-reckoning values based on the optical mouse sensors are mostly in agreement with the real trajec-

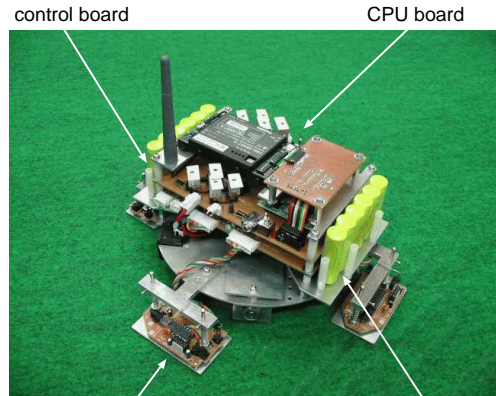

(a) Overall view of mobile robot

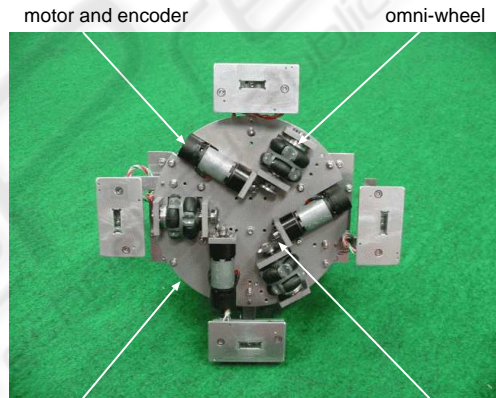

(b) Bottom view of mobile robot

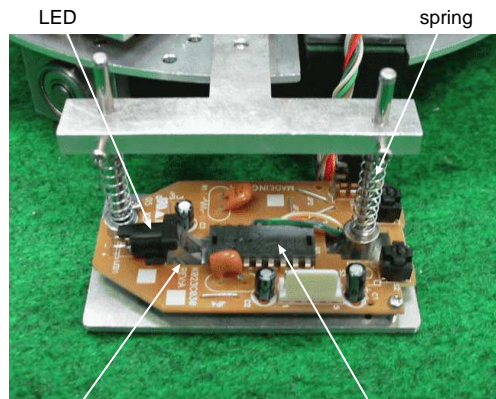

(c) Sensor unit

Figure 3: Robot equipped with omni-directional mechanism and optical mouse sensors



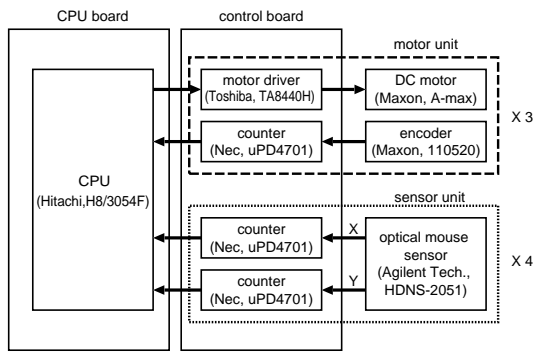

Figure 4: Control flows of the robot

Table 4: Errors in 10 dead-reckonings

(a)  $v = 300$  [mm/s],  $\omega = 1.82$  [rad/s]

type	average of the maximum error	
	translation [mm]	orientation [deg]
wheels	191.499	14.970
2 mice	44.516	4.918
4 mice	38.011	4.607

(b)  $v = 500$  [mm/s],  $\omega = 3.03$  [rad/s]

type	average of the maximum error	
	translation [mm]	orientation [deg]
wheels	239.397	19.264
2 mice	627.237	40.638
4 mice	61.593	8.588

tory. On the other hand, when robot speed is (b), the dead-reckoning value based on the wheels differs greatly from the real trajectory as well as in the case of speed (a). The method based on two optical mouse sensors caused erroneous measurements during movement, and a large error has arisen in the dead-reckoning value. On the other hand, the method based on four optical mouse sensors has carried out position estimation with a small error, since a comparison between optical mouse sensors was performed correctly.

Moreover, we verified the dead-reckoning measurements ten times under the same condition. The average of the maximum error of the estimated value and the measured value in the movement is shown in Table 4. As a result, in the ten dead-reckoning measurements, results similar to the above-mentioned are obtained, and the stability of our method can be confirmed.

### 4.3 Integration of Global Camera Information and Dead-Reckoning Value

Using another evaluation method, we report on the results of integration of the robot position via global camera and dead-reckoning value using the Kalman Filter. The handy-cam installed in the upper part of the room is used as the global camera (A separate camera is used for measuring). The global camera measures only the robot position information (orientation information is not included) for the sake of convenience. Though the extended Kalman Filter is used for integrating the two values, its details are omitted. We used  $v=500$ [mm/s] and  $\omega=3.03$ [rad/s] as the robot speed in the experiments.

Fig. 6 shows the results of (a) measurement value using the handy-cam, (b) dead-reckoning value using wheel rotation, (c) estimates based on (a) and (b), (d) dead-reckoning value using optical mouse sensors, and (e) estimates based on (a) and (c). As a result, in the case of (c), even if estimates of the position are mostly in agreement with the real trajectory, a large error has arisen in the estimates of orientation. On the other hand, in the case of (e), estimates of both position and orientation are mostly in agreement with the real trajectory. In this experiment, since the orientation is not included in the information from the global camera, the accuracy of the estimates of orientation tends to worsen compared with the estimates of position. However, by using optical mouse sensors, accurate dead-reckoning can be realized, and consequently, not only a position but also an orientation is realizable with sufficient accuracy.

## 5 CONCLUSION

In this paper, we proposed the method of accurate dead-reckoning by measuring the movement of a robot directly from the floor with optical mouse sensors. By comparing and selecting sensor values from the multiple optical sensors, reliable dead-reckoning was realized. Through several verification checks with the actual robot, we confirmed that our dead-reckoning can be realized accurately and with stability compared with the method based on wheel rotation. In addition, we showed that the accuracy of estimation was greatly improved by using only simple global camera information.

This method of measuring the movement of the robot with optical mouse sensors is limited to the indoor environment. Though the system becomes large scale in an outdoor environment, it is also possible to measure the movement of the robot by taking images of the ground surface with multiple CCD cameras as

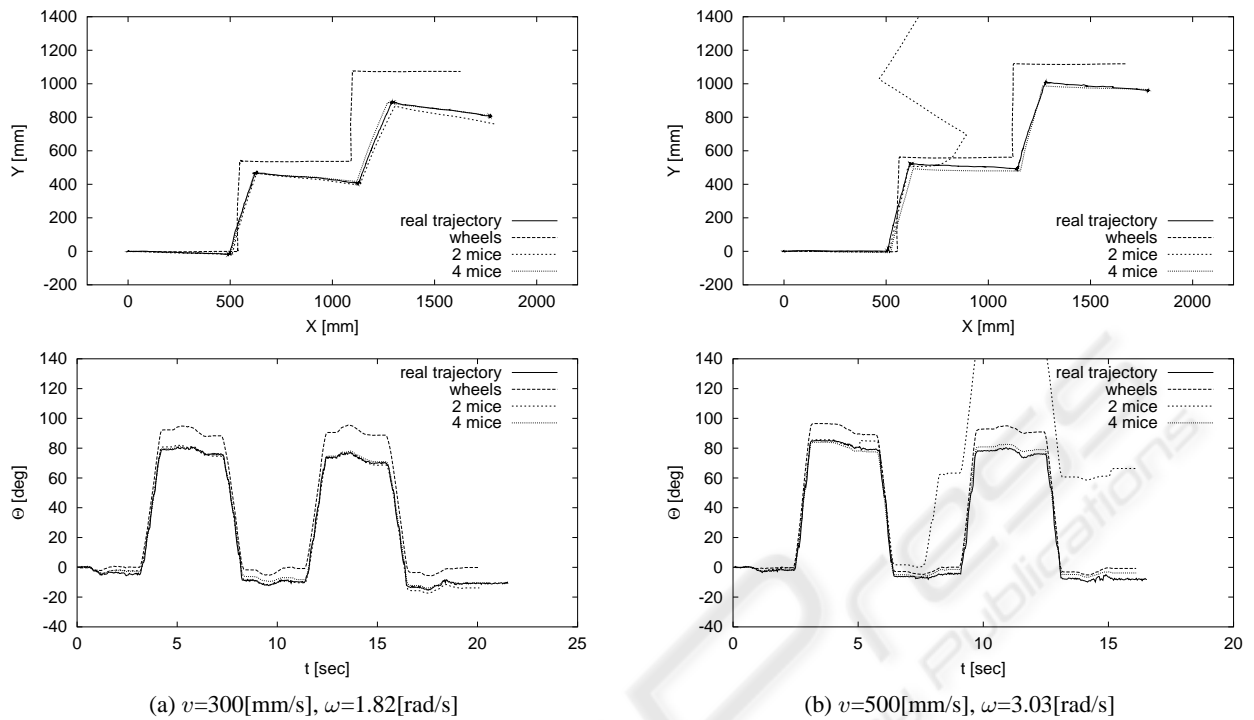

Figure 5: Self-localization based on dead-reckoning

well as optical mouse sensors. When CCD cameras are used for the measurement, our method can be introduced without the big alterations.

In future work, we will develop one sensor unit including multiple optical sensors, and install this sensor unit in various robots.

## REFERENCES

- Acroname Inc. Omni-directional poly roller wheel. <http://www.acroname.com/index.html>.
- Agilent Technologies Inc. ADNS-2051 optical mouse sensor data sheet. <http://www.agilent.com/semiconductors>.
- Chenavier, F. and Crowley, J. L. (1992). Position estimation for a mobile robot using vision and odometry. In *Proceedings of the IEEE International Conference on Robotics and Automation (ICRA'92)*, pages 2588–2593.
- Cooney, J. A., Xu, W. L., and Bright, G. (2004). Visual dead-reckoning for motion control of a mecaum-wheeled mobile robot mecaum-wheeled mobile robot. *Mechatronics*, 14:623–637.
- Cox, I. J. (1989). Blanche: position estimation for an autonomous robot vehicle. In *Proceedings of the IEEE/R SJ International workshop on Robots and Systems (IROS'89)*, pages 432–439.
- Fujimoto, R., Enomoto, M., Sekimori, D., Masutani, Y., and Miyazaki, F. (2002). Dead reckoning for mobile robots using optical mouse sensor (in Japanese). In *Proceedings of the JSME Conference on Robotics and Mechatronics (ROBOMEC'02)*, pages 1A1–G01.
- RoboCup official web site. <http://www.robocup.org/>.
- Singh, S. P. N. and Waldron, K. J. (2004). Design and evaluation of an integrated planar localization method for desktop robotics. In *Proceedings of the IEEE International Conference on Robotics and Automation (ICRA'04)*, pages 1109–1114.
- Tobe, N., Fuchiwaki, O., Misaki, D., Usuda, T., and Aoyama, H. (2004). Precise navigation for piezo based versatile miniature robot with self-gauging detector. In *Proceedings of the 1st International Conference on Positioning Technology (ICPT'04)*.
- Watanabe, Y. and Yuta, S. (1990). Position estimation of mobile robots with internal and external sensors using uncertainty evolution technique. In *Proceedings of the IEEE International Conference on Robotics and Automation (ICRA'90)*, pages 2011–2016.

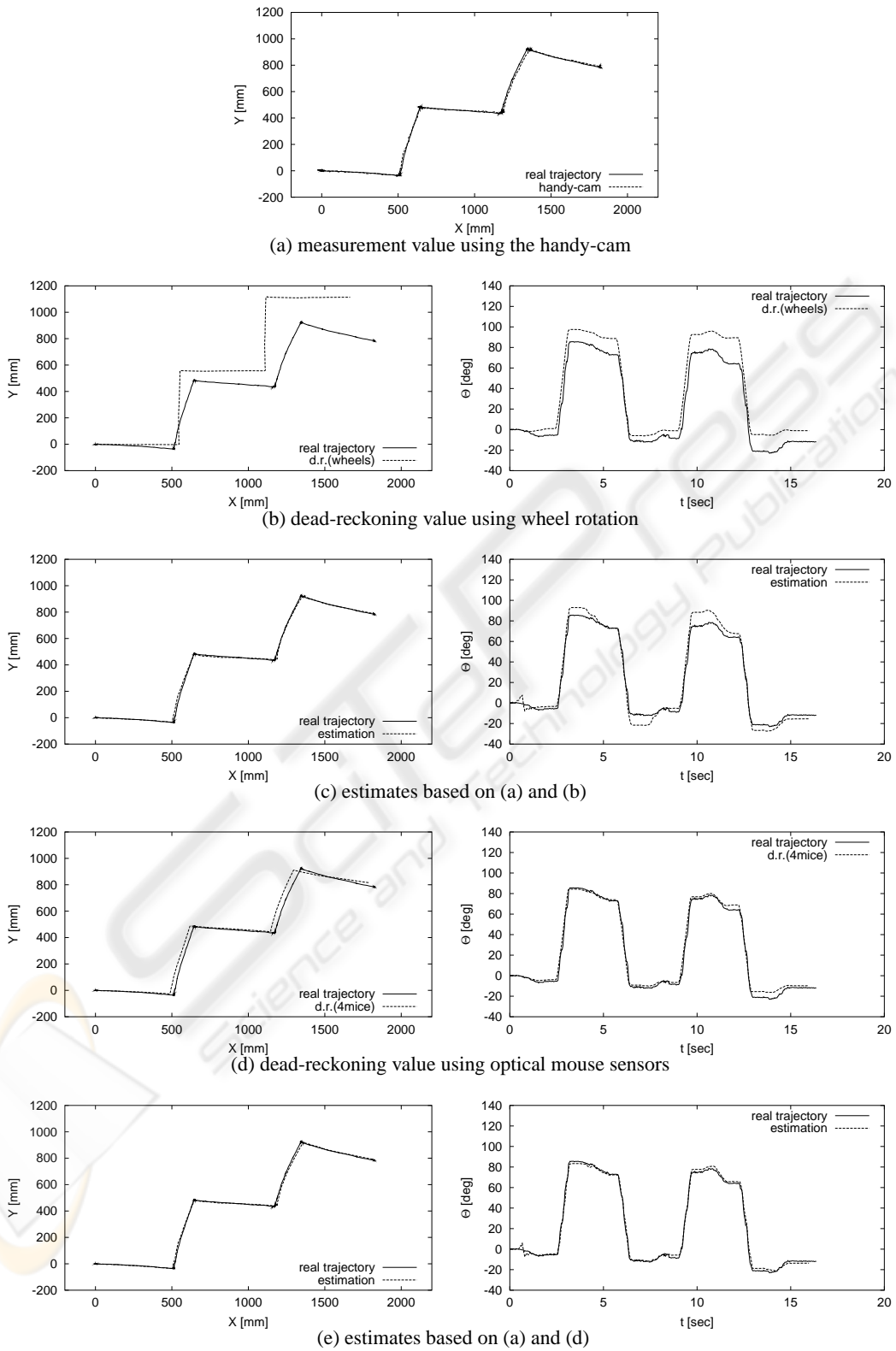

Figure 6: Self-localization based on Integration of global camera information and dead-reckoning value(  $v=500[\text{mm/s}]$ ,  $\omega=3.03[\text{rad/s}]$  )